

Electric

This document and its contents is owned by Luve Group or its affiliates and protected by laws governing intellectual property and related rights. Without limiting any rights related to this document, no part of this document may be copied, reproduced or transmitted in any form or by any means (electronic, mechanical, photocopying, recording, or otherwise), or for any purpose, without the expressed permission of Luve Group. Nor may it be used in any other way or for any other purpose than expressly permitted by Luve Group. Luve Group will enforce its rights related to this document to the fullest extent of the law, including the seeking of criminal prosecution.

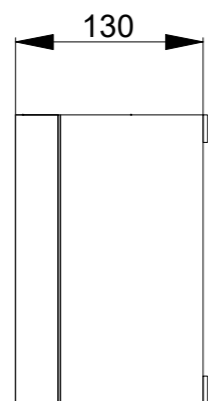

CABINET

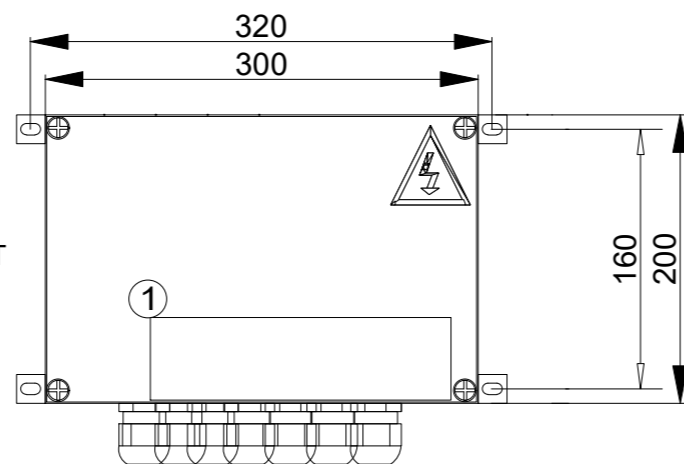

6xM25

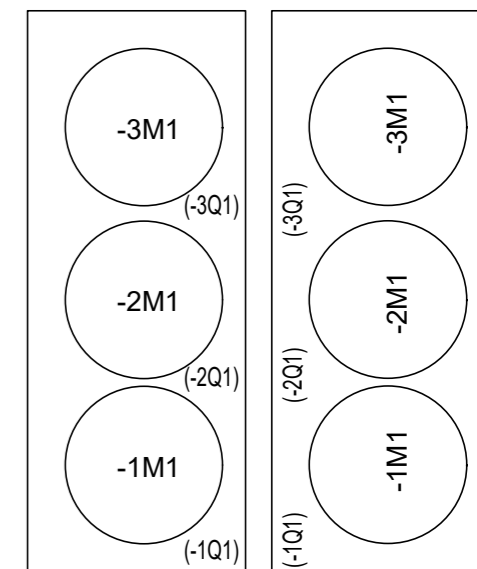
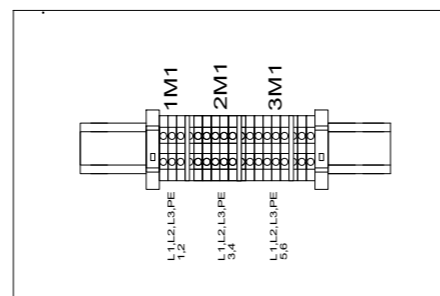

LIQUID IN

LIQUID IN

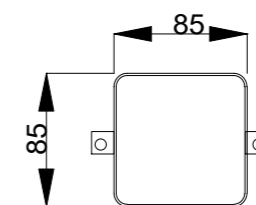

CONTROL BOX

IP 66

1

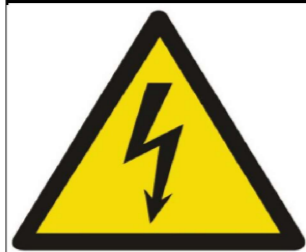

WARNING!
VAROITUS!
VARNING!
WARNUNG!
ВНИМАНИЕ!
ATTENZIONE!
AVERTISSEMENT!
ADVERTENCIA!

Wait five minutes after disconnecting the voltage at all poles before opening the device.
 Odota viisi minuuttia sen jälkeen, kun jännite on katkaistu kaikilta navoilta.
 Rör inte vid apparaten förrän fem minuter efter avstängning av spänningen på alla poler.
 Gerät erst fünf Minuten nach allpoligem Abschalten der Spannung öffnen.
 Открывайте устройство только через 5 минут после отключения напряжения по всем полюсам.
 Aprire l'apparecchio solo dopo cinque minuti dal disinserimento onnipolare della tensione.
 N'ouvrir l'appareil que cinq minutes après coupure de la tension sur tous les pôles.
 Abrir el equipo cinco minutos después de la desconexión completa de la tensión.

FAN Item number		FAN pcs	POWER kW	CURRENT A (+20°C)	RPM
9460140573/S	SM, SRM, -09TD	3	2,88	4,4	1000
9460140573/S	SM, SRM, -09SD	3	1,44 (Nom.2,88)	2,32 (Nom. 4,4)	781 (Nom. 1000)
9460140573/S	SM, SRM, -09LD	3	0,73 (Nom.2,88)	1,32 (Nom. 4,4)	612 (Nom. 1000)
9460140573/S	SM, SRM, -09QD	3	0,45 (Nom.2,88)	0,92 (Nom. 4,4)	511 (Nom. 1000)
9460140573/S	SM, SRM, -09RD	3	0,22 (Nom.2,88)	0,56 (Nom. 4,4)	385 (Nom. 1000)
9460170812/S	SM, SRM, -09LD	3	0,73	1,32	612
9460170812/S	SM, SRM, -09QD	3	0,45 (Nom. 0,73)	0,92 (Nom. 1,32)	511 (Nom. 612)
9460170812/S	SM, SRM, -09RD	3	0,22 (Nom. 0,73)	0,56 (Nom. 1,32)	385 (Nom. 612)
9460140573/S	SM, SRM, -09TY	3	2,1 (Nom.2,88)	3,23 (Nom. 4,4)	890 (Nom. 1000)
9460140573/S	SM, SRM, -09SY	3	1,04 (Nom.2,88)	1,76 (Nom. 4,4)	695 (Nom. 1000)
9460140573/S	SM, SRM, -09LY	3	0,57 (Nom.2,88)	1,10 (Nom. 4,4)	560 (Nom. 1000)
9460140573/S	SM, SRM, -09QY	3	0,30 (Nom.2,88)	0,70 (Nom. 4,4)	440 (Nom. 1000)
9460140573/S	SM, SRM, -09RY	3	0,16 (Nom.2,88)	0,48 (Nom. 4,4)	345 (Nom. 1000)
9460170812/S	SM, SRM, -09LY	3	0,57 (Nom. 0,73)	1,10 (Nom. 1,32)	560 (Nom. 612)
9460170812/S	SM, SRM, -09QY	3	0,30 (Nom. 0,73)	0,70 (Nom. 1,32)	440 (Nom. 612)
9460170812/S	SM, SRM, -09RY	3	0,16 (Nom. 0,73)	0,48 (Nom. 1,32)	345 (Nom. 612)

03	Wire layout	24.1.2020	FIVA/JMN	date	31.10.2017
02	Fan number layout added	29.10.2018	FIVA/JMN	User	FIVA/JMN
01	SD, SC --> SM	13.3.2018	FIVA/JMN	Proved	FIVA/JMN
Status	change	date	name		



CBP, 1x3

Document number: 9460145464-03

Sheet 1
Sh. 5

Electric

This document and its contents is owned by Luvé Group or its affiliates and protected by laws governing intellectual property and thereto related rights. Without limiting any rights related to this document, no part of this document may be copied, reproduced or transmitted in any form or by any means (electronic, mechanical, photocopying, recording, or otherwise), or for any purpose, without the expressed permission of Luvé Group. Nor may it be used in any other way or for any other purpose than expressly permitted by Luvé Group. Luvé Group will enforce its rights related to this document to the fullest extent of the law, including the seeking of criminal prosecution.

CUSTOMER

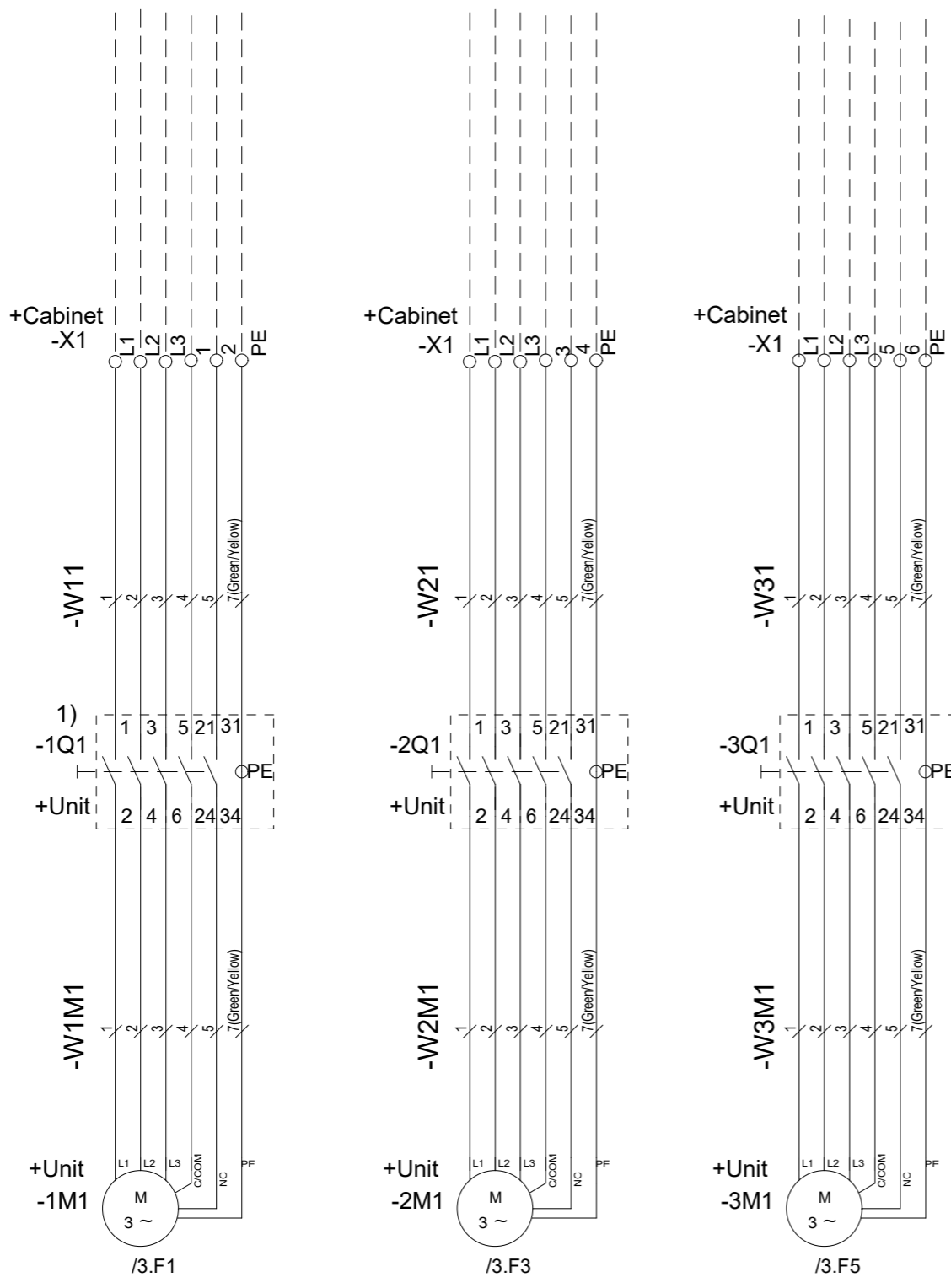

1) IF OPTION SW IS SELECTED (SM)

03	Wire layout	24.1.2020	FIVAJMN	date	31.10.2017
02	Fan number layout added	29.10.2018	FIVAJMN	User	FIVAJMN
01	SD, SC --> SM	13.3.2018	FIVAJMN	Proved	FIVAJMN
Status	change	date	name		



CBP, 1x3

Document number: 9460145464-03

Sheet 2
Sh. 5

This document and its contents is owned by Luve Group or its affiliates and protected by laws governing intellectual property and related rights. Without limiting any rights related to this document, no part of this document may be copied, reproduced or transmitted in any form or by any means (electronic, mechanical, photocopying, recording, or otherwise), or for any purpose, without the expressed permission of Luve Group. Nor may it be used in any other way or for any other purpose than expressly permitted by Luve Group. Luve Group will enforce its rights related to this document to the fullest extent of the law, including the seeking of criminal prosecution.

CUSTOMER

EXTERNAL SPEED VALUE
0 (1)-10 V

MODBUS RTU

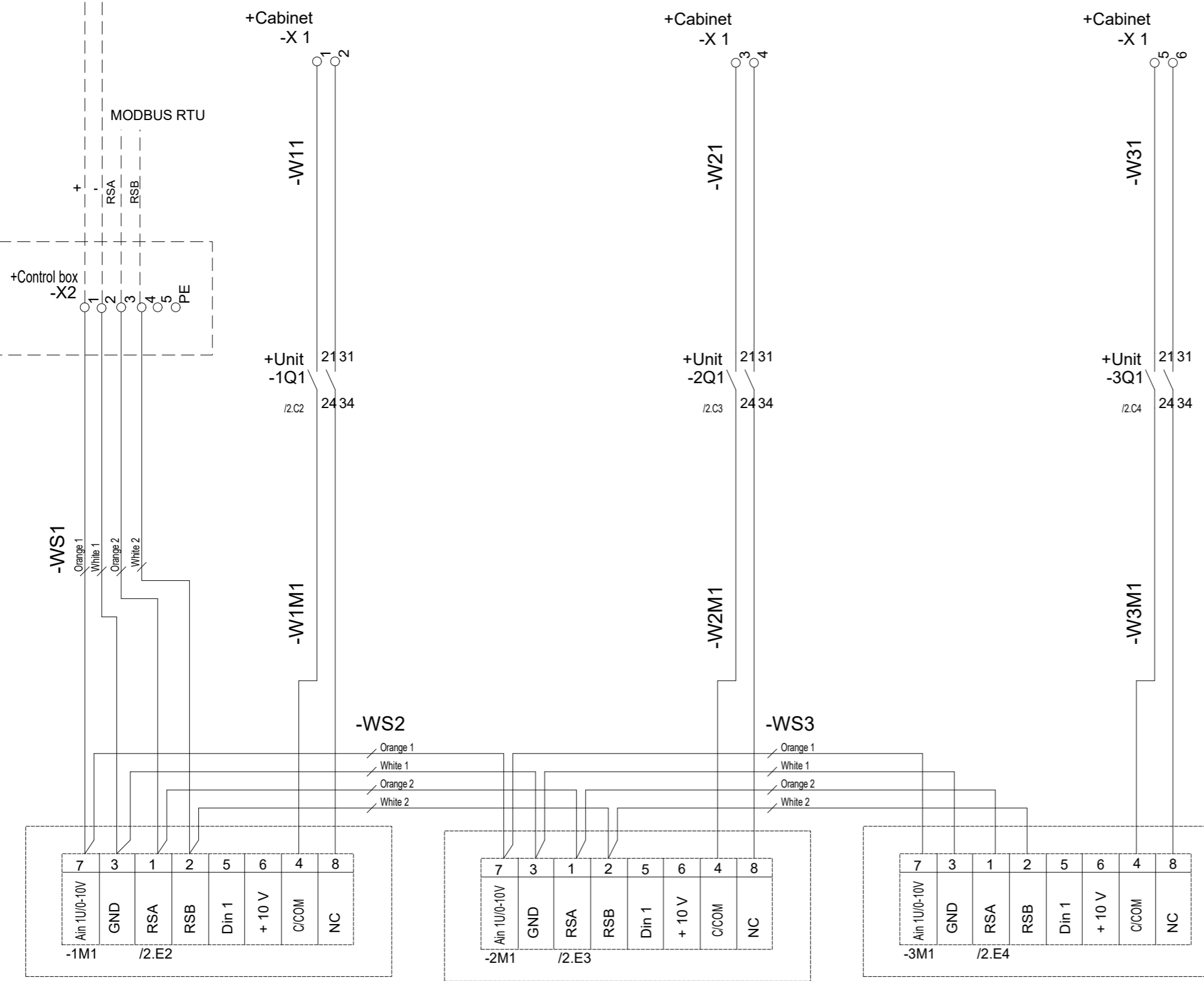

03	Wire layout	24.1.2020	FIVA/JMN	date	31.10.2017
02	Fan number layout added	29.10.2018	FIVA/JMN	User	FIVA/JMN
01	SD, SC --> SM	13.3.2018	FIVA/JMN	Proved	FIVA/JMN
Status	change	date	name		



CBP, 1x3

Document number: 9460145464-03

Sheet	3
Sh.	5

terminal strip

-X1

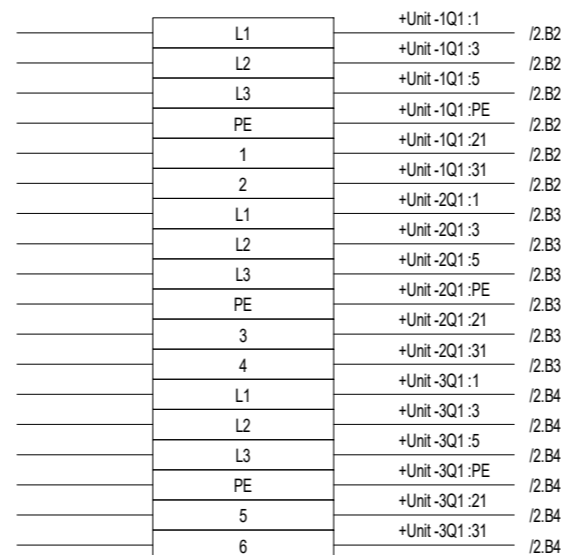

This document and its contents is owned by Luve Group or its affiliates and protected by laws governing intellectual property and therefore related to this document. Without limiting rights related to this document, the reproduction, distribution, copying, recording, or otherwise, in any form or by any means (electronic, mechanical, photocopying, recording, or otherwise) for any purpose without the expressed permission of Luve Group. Nor may it be used in any other way or for any other purpose than expressly permitted by Luve Group. Luve Group will enforce its rights related to this document to the fullest extent of the law, including the seeking of criminal prosecution.

03	Wire layout	24.1.2020	FIVAJMN	date	31.10.2017
02	Fan number layout added	29.10.2018	FIVAJMN	User	FIVAJMN
01	SD. SC --> SM	13.3.2018	FIVAJMN	Proved	FIVAJMN
Status	change	date	name		



CBP, 1x3

+Cabinet

Document number: 9460145464-03

Sheet 4
Sh. 5

terminal strip

-X2

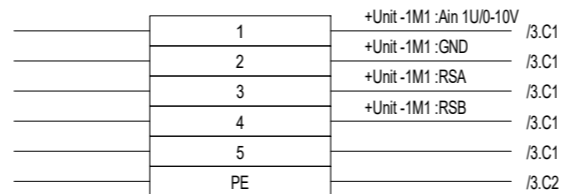

This document and its contents is owned by Luve Group or its affiliates and protected by laws governing intellectual property and therefore related to this document. Without limiting rights related to this document, the reproduction, distribution, copying, or otherwise, in any form or by any means (electronic, mechanical, photocopying, recording, or otherwise) for any purpose without the expressed permission of Luve Group. Nor may it be used in any other way or for any other purpose than expressly permitted by Luve Group. Luve Group will enforce its rights related to this document to the fullest extent of the law, including the seeking of criminal prosecution.

03	Wire layout	24.1.2020	FIVA JMN	date	31.10.2017
02	Fan number layout added	29.10.2018	FIVA JMN	User	FIVA JMN
01	SD. SC --> SM	13.3.2018	FIVA JMN	Proved	FIVA JMN
Status	change	date	name		



CBP, 1x3

Document number: 9460145464-03

Sheet 5
Sh. 5

+Control box