

Electric

This document and its contents are owned by Luve Group or its affiliates and protected by laws governing intellectual property and related rights. Without limiting any rights related to this document, no part of this document may be copied, reproduced or transmitted in any form or by any means (electronic, mechanical, photocopying, recording, or otherwise), or for any purpose, without the expressed permission of Luve Group. Nor may it be used in any other way or for any other purpose than expressly permitted by Luve Group. Luve Group will enforce its rights related to this document to the fullest extent of the law, including the seeking of criminal prosecution.

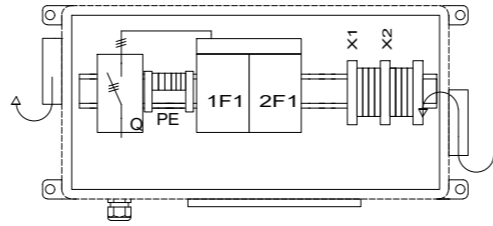

1xM25 + LMC25

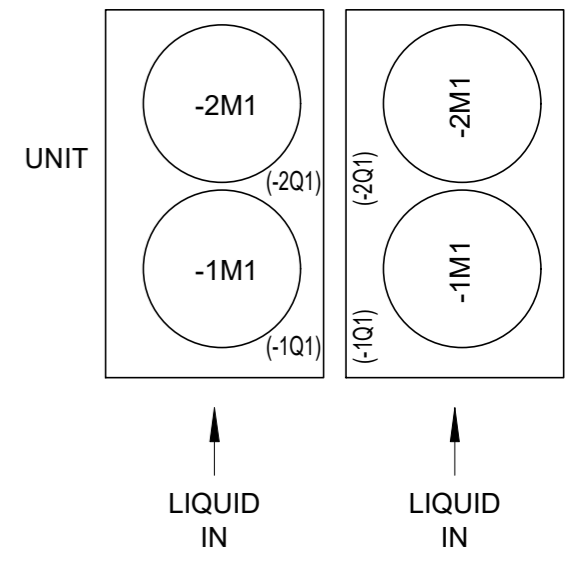
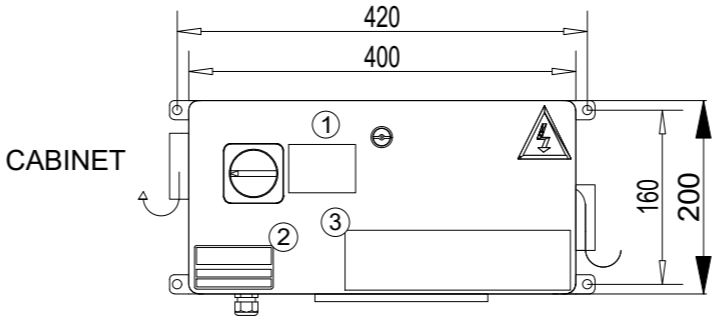

1xM25 + LMC25

| FAN Item number | | FAN pcs | POWER kW | CURRENT A (+20°C) | RPM |
|-----------------|----------------|---------|------------------|-------------------|-----------------|
| 9460140573/S | SM, SRM, -09TD | 2 | 2,88 | 4,4 | 1000 |
| 9460140573/S | SM, SRM, -09SD | 2 | 1,44 (Nom.2,88) | 2,32 (Nom. 4,4) | 781 (Nom. 1000) |
| 9460140573/S | SM, SRM, -09LD | 2 | 0,73 (Nom.2,88) | 1,32 (Nom. 4,4) | 612 (Nom. 1000) |
| 9460140573/S | SM, SRM, -09QD | 2 | 0,45 (Nom.2,88) | 0,92 (Nom. 4,4) | 511 (Nom. 1000) |
| 9460140573/S | SM, SRM, -09RD | 2 | 0,22 (Nom.2,88) | 0,56 (Nom. 4,4) | 385 (Nom. 1000) |
| 9460170812/S | SM, SRM, -09LD | 2 | 0,73 | 1,32 | 612 |
| 9460170812/S | SM, SRM, -09QD | 2 | 0,45 (Nom. 0,73) | 0,92 (Nom. 1,32) | 511 (Nom. 612) |
| 9460170812/S | SM, SRM, -09RD | 2 | 0,22 (Nom. 0,73) | 0,56 (Nom. 1,32) | 385 (Nom. 612) |
| 9460140573/S | SM, SRM, -09TY | 2 | 2,1 (Nom.2,88) | 3,23 (Nom. 4,4) | 890 (Nom. 1000) |
| 9460140573/S | SM, SRM, -09SY | 2 | 1,04 (Nom.2,88) | 1,76 (Nom. 4,4) | 695 (Nom. 1000) |
| 9460140573/S | SM, SRM, -09LY | 2 | 0,57 (Nom.2,88) | 1,10 (Nom. 4,4) | 560 (Nom. 1000) |
| 9460140573/S | SM, SRM, -09QY | 2 | 0,30 (Nom.2,88) | 0,70 (Nom. 4,4) | 440 (Nom. 1000) |
| 9460140573/S | SM, SRM, -09RY | 2 | 0,16 (Nom.2,88) | 0,48 (Nom. 4,4) | 345 (Nom. 1000) |
| 9460170812/S | SM, SRM, -09LY | 2 | 0,57 (Nom. 0,73) | 1,10 (Nom. 1,32) | 560 (Nom. 612) |
| 9460170812/S | SM, SRM, -09QY | 2 | 0,30 (Nom. 0,73) | 0,70 (Nom. 1,32) | 440 (Nom. 612) |
| 9460170812/S | SM, SRM, -09RY | 2 | 0,16 (Nom. 0,73) | 0,48 (Nom. 1,32) | 345 (Nom. 612) |

①

MAIN SWITCH
PÄÄKYTKIN
HUVUDBRYTARE
HAUPTSCHALTER
ГЛАВНЫЙ ВЫКЛЮЧАТЕЛЬ
INTERRUPTORE PRINCIPALE
INTERUPTEUR PRINCIPAL
INTERRUPTOR PRINCIPAL

②

| | | | |
|----------|----------|------|--------|
| Model | ECCB 1x2 | | |
| In/A | 16 | Un/V | 400 ac |
| Icc/kA | IP | 65 | |
| Type.no. | EN 61439 | | |

③

WARNING!
VAROITUS!
VARNING!
WARNUNG!
ВНИМАНИЕ!
ATTENZIONE!
AVERTISSEMENT!
ADVERTENCIA!

Wait five minutes after disconnecting the voltage at all poles before opening the device.
 Odota viisi minuuttia sen jälkeen, kun jännite on katkaistu kaikilta navoilta.
 Rör inte vid apparaten förrän fem minuter efter avstängning av spänningen på alla poler.
 Gerät erst fünf Minuten nach allpoligem Abschalten der Spannung öffnen.
 Открывайте устройство только через 5 минут после отключения напряжения по всем полюсам.
 Aprire l'apparecchio solo dopo cinque minuti dal disinserimento onnipolare della tensione.
 N'ouvrir l'appareil que cinq minutes après coupure de la tension sur tous les pôles.
 Abrir el equipo cinco minutos después de la desconexión completa de la tensión.

| | | | | | |
|--------|-------------------------|------------|----------|--------|----------|
| 08 | Cable glands->Multigate | 16.12.2019 | FIVA/JMN | date | 6.7.2015 |
| 07 | Wire layout | 12.3.2019 | FIVA/JMN | User | FIVAMHA |
| 06 | Fan number layout added | 29.10.2018 | FIVA/JMN | Proved | FIVA/JMN |
| Status | change | date | name | | |



ECCB
9460148081

Electric

This document and its contents is owned by Luve Group or its affiliates and protected by laws governing intellectual property and related rights. Without limiting any rights related to this document, no part of this document may be copied, reproduced or transmitted in any form or by any means (electronic, mechanical, photocopying, recording, or otherwise), or for any purpose, without the expressed permission of Luve Group. Nor may it be used in any other way or for any other purpose than expressly permitted by Luve Group. Luve Group will enforce its rights related to this document to the fullest extent of the law, including the seeking of criminal prosecution.

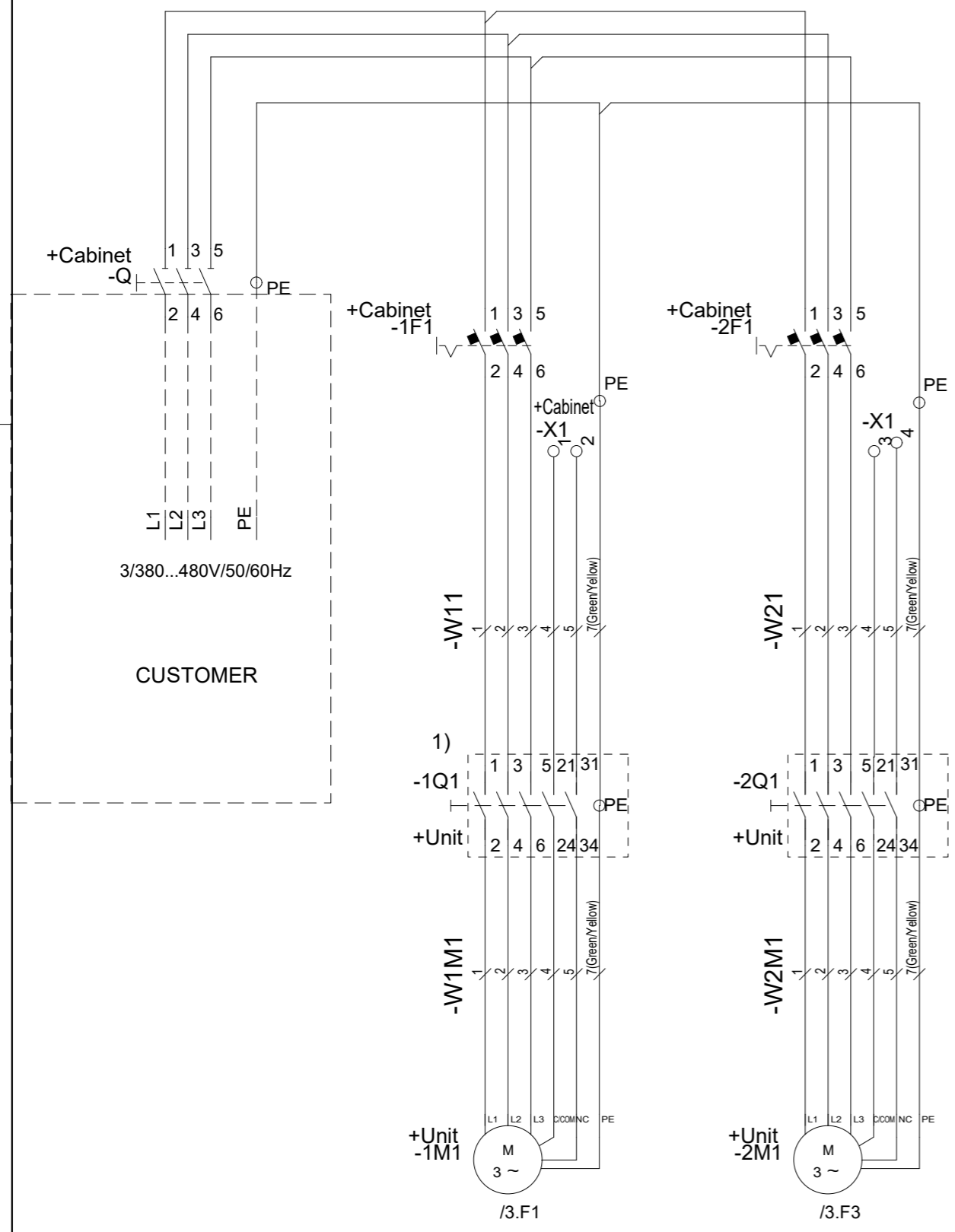

1) IF OPTION SW IS SELECTED (SM)

| | | | | | |
|--------|-------------------------|------------|----------|--------|----------|
| 08 | Cable glands->Multigate | 16.12.2019 | FIVA/JMN | date | 6.7.2015 |
| 07 | Wire layout | 12.3.2019 | FIVA/JMN | User | FIVAMHA |
| 06 | Fan number layout added | 29.10.2018 | FIVA/JMN | Proved | FIVA/JMN |
| Status | change | date | name | | |



ECCB
9460148081

Document number: 9460148081-08

Sheet 2
Sh. 5

Electric

This document and its contents is owned by Luve Group or its affiliates and protected by laws governing intellectual property and related rights. Without limiting any rights related to this document, no part of this document may be copied, reproduced or transmitted in any form or by any means (electronic, mechanical, photocopying, recording, or otherwise), or for any purpose, without the expressed permission of Luve Group. Nor may it be used in any other way or for any other purpose than expressly permitted by Luve Group. Luve Group will enforce its rights related to this document to the fullest extent of the law, including the seeking of criminal prosecution.

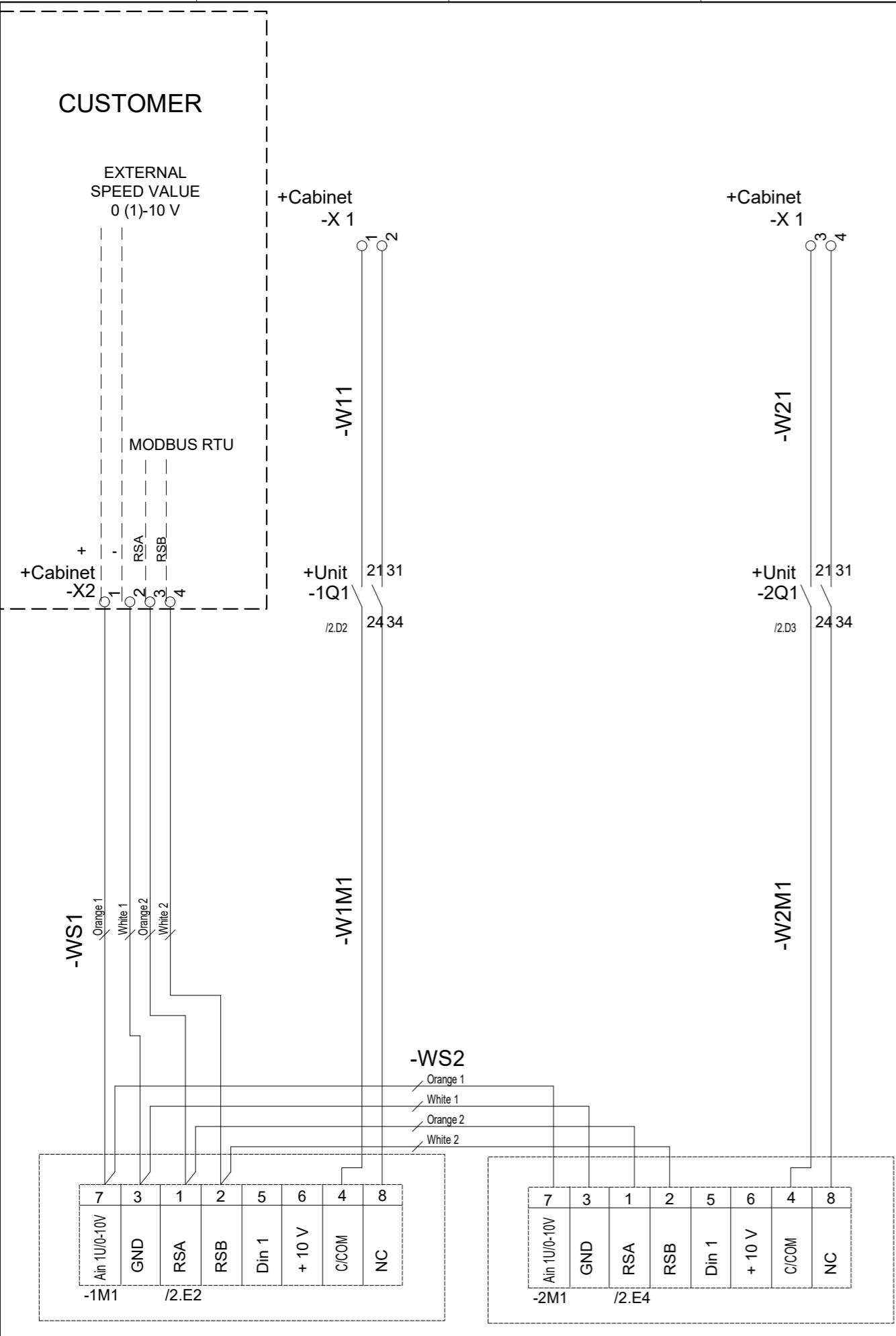

| | | | | | |
|--------|-------------------------|------------|----------|--------|----------|
| 08 | Cable glands->Multigate | 16.12.2019 | FIVA/JMN | date | 6.7.2015 |
| 07 | Wire layout | 12.3.2019 | FIVA/JMN | User | FIVAMHA |
| 06 | Fan number layout added | 29.10.2018 | FIVA/JMN | Proved | FIVA/JMN |
| Status | change | date | name | | |



ECCB
9460148081

| | | |
|------------------|---------------|---------|
| Document number: | 9460148081-08 | Sheet 3 |
| | | Sh. 5 |

terminal strip

-X1

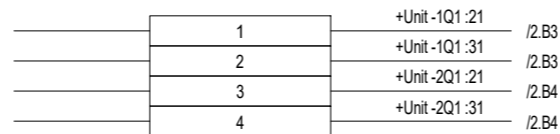

This document and its contents is owned by Luve Group or its affiliates and protected by laws governing intellectual property and therefore related to this document. Wire is containing rights related to this document. This document is not to be reproduced, stored in a retrieval system, or transmitted in any form or by any means (electronic, mechanical, photocopying, recording, or otherwise) for any purpose without the expressed permission of Luve Group. Nor may it be used in any other way or for any other purpose than expressly permitted by Luve Group. Luve Group will enforce its rights related to this document to the fullest extent of the law, including the seeking of criminal prosecution.

| | | | | | |
|--------|-------------------------|------------|---------|--------|----------|
| 08 | Cable clands->Multigate | 16.12.2019 | FIVAJMN | date | 6.7.2015 |
| 07 | Wire layout | 12.3.2019 | FIVAJMN | User | FIVAMHA |
| 06 | Fan number layout added | 29.10.2018 | FIVAJMN | Proved | FIVAJMN |
| Status | change | date | name | | |



ECCB
9460148081

Document number: 9460148081-08

Sheet 4
Sh. 5

terminal strip

-X2

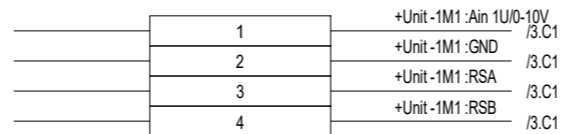

This document and its contents is owned by Luve Group or its affiliates and protected by laws governing intellectual property and therefore related to this. Without limiting rights related to this document, this document is not to be copied, reproduced, stored in a retrieval system, or transmitted in any form or by any means (electronic, mechanical, photocopying, recording, or otherwise) for any purpose without the expressed permission of Luve Group. Nor may it be used in any other way or for any other purpose than expressly permitted by Luve Group. Luve Group will enforce its rights related to this document to the fullest extent of the law, including the seeking of criminal prosecution.

| | | | | | |
|--------|-------------------------|------------|---------|--------|----------|
| 08 | Cable clands->Multigate | 16.12.2019 | FIVAJMN | date | 6.7.2015 |
| 07 | Wire layout | 12.3.2019 | FIVAJMN | User | FIVAMHA |
| 06 | Fan number layout added | 29.10.2018 | FIVAJMN | Proved | FIVAJMN |
| Status | change | date | name | | |



ECCB
9460148081

Document number: 9460148081-08

| | |
|-------|---|
| Sheet | 5 |
| Sh. | 5 |