

Electric

This document and its contents are owned by Luve Group or its affiliates and protected by laws governing intellectual property and related rights. Without limiting any rights related to this document, no part of this document may be copied, reproduced or transmitted in any form or by any means (electronic, mechanical, photocopying, recording, or otherwise), or for any purpose, without the expressed permission of Luve Group. Nor may it be used in any other way or for any other purpose than expressly permitted by Luve Group. Luve Group will enforce its rights related to this document to the fullest extent of the law, including the seeking of criminal prosecution.

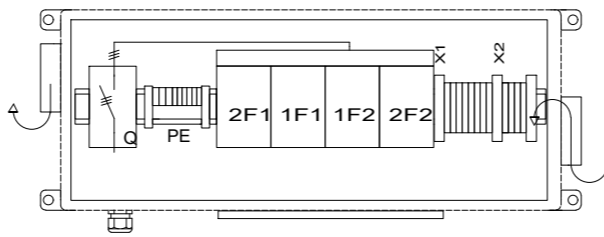

1xM32 + LMC25

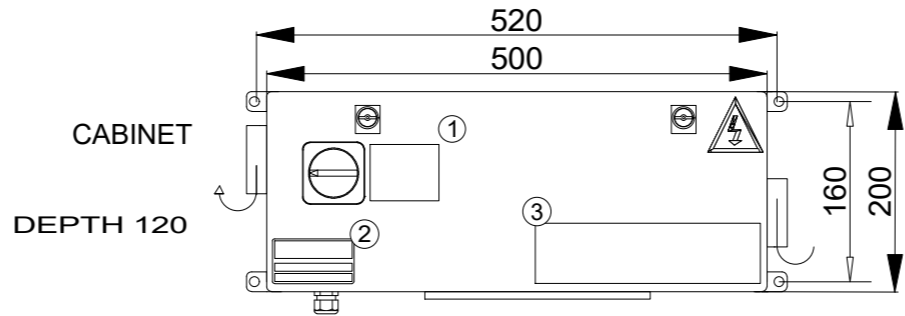

CABINET
DEPTH 120

1xM32 + LMC25

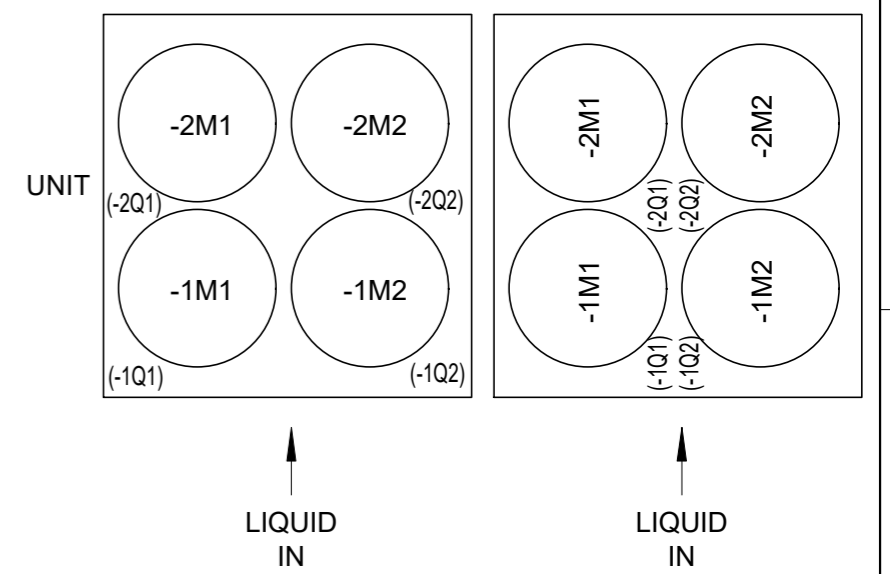

LIQUID IN

LIQUID IN

FAN Item number		FAN pcs	POWER kW	CURRENT A (+20°C)	RPM
9460140573/S	SD, SRD, -09TD	4	2,88	4,4	1000
9460140573/S	SD, SRD, -09SD	4	1,44 (Nom.2,88)	2,32 (Nom. 4,4)	781 (Nom. 1000)
9460140573/S	SD, SRD, -09LD	4	0,73 (Nom.2,88)	1,32 (Nom. 4,4)	612 (Nom. 1000)
9460140573/S	SD, SRD, -09QD	4	0,45 (Nom.2,88)	0,92 (Nom. 4,4)	511 (Nom. 1000)
9460140573/S	SD, SRD, -09RD	4	0,22 (Nom.2,88)	0,56 (Nom. 4,4)	385 (Nom. 1000)
9460170812/S	SD, SRD, -09LD	4	0,73	1,32	612
9460170812/S	SD, SRD, -09QD	4	0,45 (Nom. 0,73)	0,92 (Nom. 1,32)	511 (Nom. 612)
9460170812/S	SD, SRD, -09RD	4	0,22 (Nom. 0,73)	0,56 (Nom. 1,32)	385 (Nom. 612)
9460140573/S	SD, SRD, -09TY	4	2,1 (Nom.2,88)	3,23 (Nom. 4,4)	890 (Nom. 1000)
9460140573/S	SD, SRD, -09SY	4	1,04 (Nom.2,88)	1,76 (Nom. 4,4)	695 (Nom. 1000)
9460140573/S	SD, SRD, -09LY	4	0,57 (Nom.2,88)	1,10 (Nom. 4,4)	560 (Nom. 1000)
9460140573/S	SD, SRD, -09QY	4	0,30 (Nom.2,88)	0,70 (Nom. 4,4)	440 (Nom. 1000)
9460140573/S	SD, SRD, -09RY	4	0,16 (Nom.2,88)	0,48 (Nom. 4,4)	345 (Nom. 1000)
9460170812/S	SD, SRD, -09LY	4	0,57 (Nom. 0,73)	1,10 (Nom. 1,32)	560 (Nom. 612)
9460170812/S	SD, SRD, -09QY	4	0,30 (Nom. 0,73)	0,70 (Nom. 1,32)	440 (Nom. 612)
9460170812/S	SD, SRD, -09RY	4	0,16 (Nom. 0,73)	0,48 (Nom. 1,32)	345 (Nom. 612)

①
MAIN SWITCH
PÄÄKYTKIN
HUVUDBRYTARE
HAUPTSCHALTER
ГЛАВНЫЙ ВЫКЛЮЧАТЕЛЬ
INTERRUPTORE PRINCIPALE
INTERUPTEUR PRINCIPAL
INTERRUPTOR PRINCIPAL

②

Model	ECCB 2x2
In/A/A	25 Un/V 400 ac
Icc/kA	IP 65
Type.no.	EN 61439

③

WARNING!
VAROITUS!
VARNING!
WARNUNG!
ВНИМАНИЕ!
ATTENZIONE!
AVERTISSEMENT!
ADVERTENCIA!

Wait five minutes after disconnecting the voltage at all poles before opening the device.
 Odota viisi minuuttia sen jälkeen, kun jännite on katkaistu kaikilta navoilta.
 Rör inte vid apparaten förrän fem minuter efter avstängning av spänningen på alla poler.
 Gerät erst fünf Minuten nach allpoligem Abschalten der Spannung öffnen.
 Открывайте устройство только через 5 минут после отключения напряжения по всем полюсам.
 Aprire l'apparechio solo dopo cinque minuti dal disinserimento onnipolare della tensione.
 N'ouvrir l'appareil que cinq minutes après coupure de la tension sur tous les pôles.
 Abrir el equipo cinco minutos después de la desconexión completa de la tensión.

09	Cable glands->Multigate	9.1.2020	FIVA/JMN	date	30.7.2015
08	Details added	14.3.2019	FIVA/JMN	User	FIVA/JMN
07	Wire layout	6.2.2019	FIVA/JMN	Proved	FIVA/JMN
Status	change	date	name		



ECCB
9460148974

Document number: 9460148974-09 Sheet 1 Sh. 5

Electric

This document and its contents is owned by Luvé Group or its affiliates and protected by laws governing intellectual property and related rights. Without limiting any rights related to this document, no part of this document may be copied, reproduced or transmitted in any form or by any means (electronic, mechanical, photocopying, recording, or otherwise), or for any purpose, without the expressed permission of Luvé Group. Nor may it be used in any other way or for any other purpose than expressly permitted by Luvé Group. Luvé Group will enforce its rights related to this document to the fullest extent of the law, including the seeking of criminal prosecution.

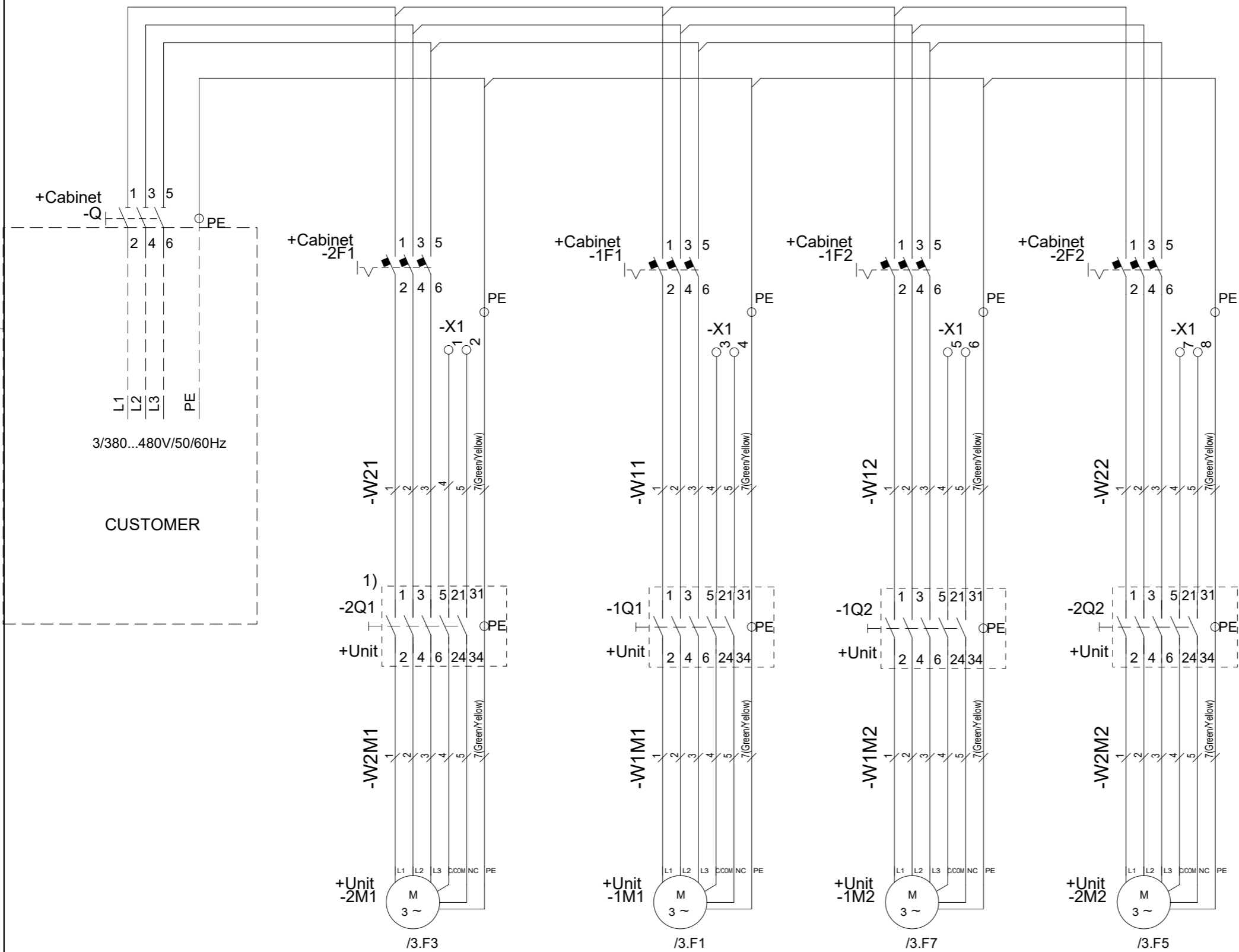

1) IF OPTION SW IS SELECTED (SD)

09	Cable glands->Multigate	9.1.2020	FIVA/JMN	date	30.7.2015
08	Details added	14.3.2019	FIVA/JMN	User	FIVA/JMN
07	Wire layout	6.2.2019	FIVA/JMN	Proved	FIVA/JMN
Status	change	date	name		



ECCB
9460148974

Document number: 9460148974-09

Sheet 2
Sh. 5

This document and its contents is owned by Luve Group or its affiliates and protected by laws governing intellectual property and related rights. Without limiting any rights related to this document, no part of this document may be copied, reproduced or transmitted in any form or by any means (electronic, mechanical, photocopying, recording, or otherwise), or for any purpose, without the expressed permission of Luve Group. Nor may it be used in any other way or for any other purpose than expressly permitted by Luve Group. Luve Group will enforce its rights related to this document to the fullest extent of the law, including the seeking of criminal prosecution.

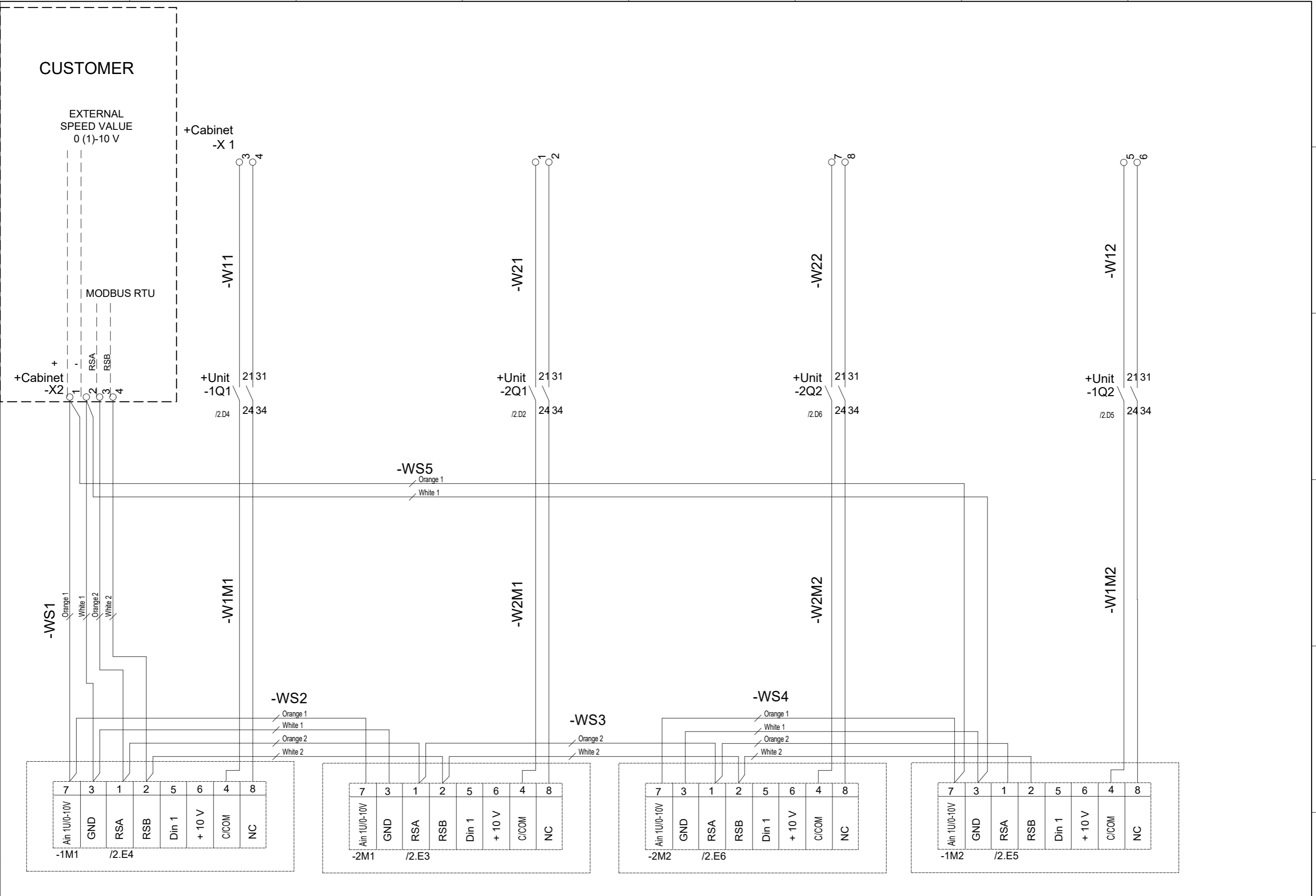

09	Cable glands->Multigate	9.1.2020	FIVA/JMN	date	30.7.2015
08	Details added	14.3.2019	FIVA/JMN	User	FIVA/JMN
07	Wire layout	6.2.2019	FIVA/JMN	Proved	FIVA/JMN
Status	change	date	name		



ECCB
9460148974

terminal strip

-X1

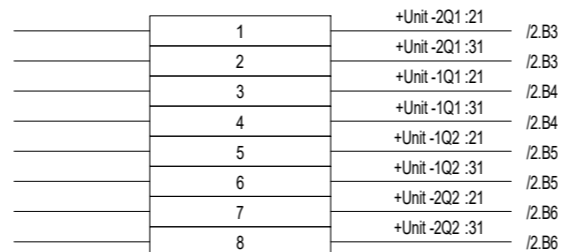

This document and its contents is owned by Luve Group or its affiliates and protected by laws governing intellectual property and therefore related to this document. Without limiting rights related to this document, this document is not to be reproduced, stored in a retrieval system, or transmitted in any form or by any means (electronic, mechanical, photocopying, recording, or otherwise) for any purpose without the expressed permission of Luve Group. Nor may it be used in any other way or for any other purpose than expressly permitted by Luve Group. Luve Group will enforce its rights related to this document to the fullest extent of the law, including the seeking of criminal prosecution.

09	Cable glands->Multigate	9.1.2020	FIVAJMN	date	30.7.2015
08	Details added	14.3.2019	FIVAJMN	User	FIVAJMN
07	Wire layout	6.2.2019	FIVAJMN	Proved	FIVAJMN
Status	change	date	name		



ECCB
9460148974

+Cabinet
Document number: 9460148974-09
Sheet 4
Sh. 5

terminal strip

-X2

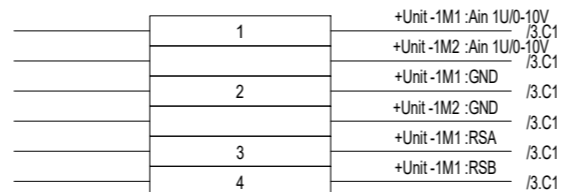

This document and its contents is owned by Luve Group or its affiliates and protected by laws governing intellectual property and therefore related to this document. Without limiting rights related to this document, this document is not to be reproduced, stored in a retrieval system, or transmitted in any form or by any means (electronic, mechanical, photocopying, recording, or otherwise) for any purpose without the expressed permission of Luve Group. Nor may it be used in any other way or for any other purpose than expressly permitted by Luve Group. Luve Group will enforce its rights related to this document to the fullest extent of the law, including the seeking of criminal prosecution.

09	Cable glands->Multigate	9.1.2020	FIVAJMN	date	30.7.2015
08	Details added	14.3.2019	FIVAJMN	User	FIVAJMN
07	Wire layout	6.2.2019	FIVAJMN	Proved	FIVAJMN
Status	change	date	name		



ECCB
9460148974

+Cabinet
Document number: 9460148974-09
Sheet 5
Sh. 5