

ALFABLUE JR - EC motors three phase

drawing number: 9460171243



alfa.luvegroup.com

BOARD RATED VALUE

VOLTAGE DC	---
VOLTAGE AC	400 Vac \pm 10%
FREQUENCY	50 - 60 Hz \pm 2%
POWER MAX	
SHORT CIRCUIT CURRENT (Icc)	
IP DEGREE WITH CLOSED DOORS	IP54
IP DEGREE WITH OPENED DOORS	IP20

This document and its contents is owned by LU-VE Group or its affiliates and protected by laws governing intellectual property and thereto related rights. Without limiting any rights related to this document, no part of this document may be copied, reproduced or transmitted in any form or by any means (electronic, mechanical, photocopying, recording, or otherwise), or for any purpose, without the expressed permission of LU-VE Group. Nor may it be used in any other way or for any other purpose than expressly permitted by LU-VE Group. LU-VE Group will enforce its rights related to this document to the fullest extent of the law, including the seeking of criminal prosecution.

























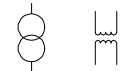



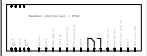

02	New brand	18/12/2019	PCIA	User	18/12/2019	ITALPCIA
01	Pressure transducer	08/05/2018	DRI	Proved	D. Rizzotti	
Status	change	date	name			



HEADING PAGE

Document number: 9460171243-02 Sheet 1
Sh. 12

This document and its contents is owned by LU-VE Group or its affiliates and protected by laws governing intellectual property and thereto related rights. Without limiting any rights related to this document, no part of this document may be copied, reproduced or transmitted in any form or by any means (electronic, mechanical, photocopying, recording, or otherwise), or for any purpose, without the expressed permission of LU-VE Group. Nor may it be used in any other way or for any other purpose than expressly permitted by LU-VE Group. LU-VE Group will enforce its rights related to this document to the fullest extent of the law, including the seeking of criminal prosecution.

	ELECTRIC MOTOR		THERMAL PROTECTION CONTROL		RESISTOR		MANUALLY OPERATED SWITCH
	TERMINALS		CONVERTER		VARIABLE RESISTOR		MAINTENANCE SWITCH
	EARTHING		ELECTRONIC MOTOR		HEATER		OPEN CONTACT
	WIRES CONNECTION		CUT-PHASE SPEED CONTROLLER SINGLE PHASE		VOLTAGE TRANSFORMER		CLOSED CONTACT
	T-CONNECTION		CUT-PHASE SPEED CONTROLLER THREE PHASE		PLUG AND SOCKET		CHANGEOVER CONTACT
	SERIE CONNECTION		MASTER CONTROLLER EC REGULATOR		FEMALE CONTACT (OF A SOCKET OR PLUG)		MAKE CONTACT, DELAYED WHEN THE DEVICE CONTAINING THE CONTACT IS BEING ACTIVATED
	PARALLEL CONNECTION		SAFETY OR EMERGENCY CONTROL WITH MUSHROOM PUSH-BUTTON		MALE CONTACT (OF A SOCKET OR PLUG)		BREAK CONTACT, DELAYED WHEN THE DEVICE CONTAINING THE CONTACT IS BEING DE-ACTIVATED
	ROTATIVE CONTROL		KEY CONTROL		PUSH-BUTTON CONTROL		PUSH-BUTTON CONTROL

02	New brand	18/12/2019	PCIA	User	18/12/2019	ITALPCIA
01	Pressure transducer	08/05/2018	DRI	Proved	D. Rizzotti	
Status	change	date	name			



SYMBOLS

LABELING ELECTRICAL COMPONENTS

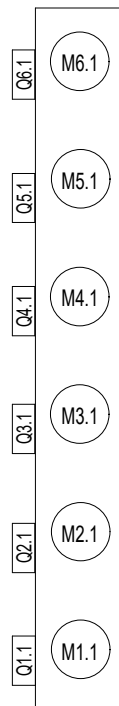

↓
HEADER SIDE

This document and its contents is owned by LU-VE Group or its affiliates and protected by laws governing intellectual property and thereto related rights. Without limiting any rights related to this document, no part of this document may be copied, reproduced or transmitted in any form or by any means (electronic, mechanical, photocopying, recording, or otherwise), or for any purpose, without the expressed permission of LU-VE Group. Nor may it be used in any other way or for any other purpose than expressly permitted by LU-VE Group. LU-VE Group will enforce its rights related to this document to the fullest extent of the law, including the seeking of criminal prosecution.

02	New brand	18/12/2019	PCIA	User	18/12/2019	ITALPCIA
01	Pressure transducer	08/05/2018	DRI	Proved	D. Rizzotti	
Status	change	date	name			



UNIT LAYOUT

Document number: 9460171243-02

Sheet 4
Sh. 12

Q1.1 - Q6.1

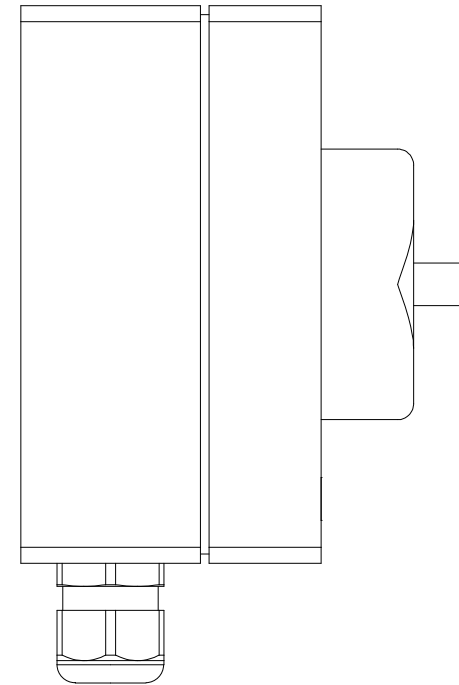
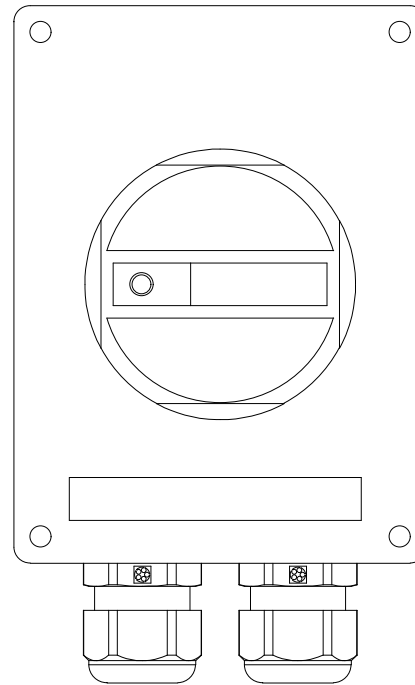
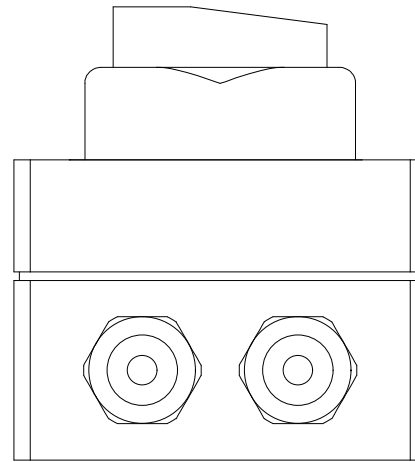

Technical data

Material: Polycarbonate
IP protection class: IP66
Color: Grey/black
Rated insulation voltage: 690V
Rated operational current: 16A
Ambient temperature: -40/+80°C

This document and its contents is owned by LU-VE Group or its affiliates and protected by laws governing intellectual property and thereto related rights. Without limiting any rights related to this document, no part of this document may be copied, reproduced or transmitted in any form or by any means (electronic, mechanical, photocopying, recording, or otherwise), or for any purpose, without the expressed permission of LU-VE Group. Nor may it be used in any other way or for any other purpose than expressly permitted by LU-VE Group. LU-VE Group will enforce its rights related to this document to the fullest extent of the law, including the seeking of criminal prosecution.

02	New brand	18/12/2019	PCIA	User	18/12/2019	ITALPCIA
01	Pressure transducer	08/05/2018	DRI	Proved	D. Rizzotti	
Status	change	date	name			



SWITCH LAYOUT

Document number: 9460171243-02

Sheet 5
Sh. 12

SB

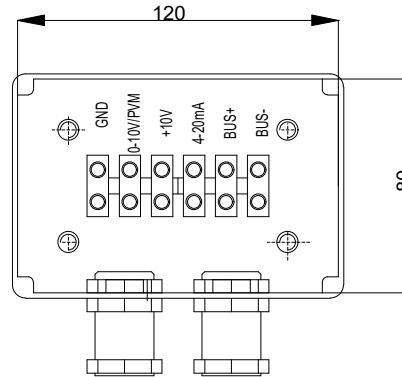

Technical data

Material: Plastic
 IP protection class: IP54
 Color: RAL7035
 Rated insulation voltage: 500V
 Ambient temperature: -25/+60°C

This document and its contents is owned by LU-VE Group or its affiliates and protected by laws governing intellectual property and thereto related rights. Without limiting any rights related to this document, no part of this document may be copied, reproduced or transmitted in any form or by any means (electronic, mechanical, photocopying, recording, or otherwise), or for any purpose, without the expressed permission of LU-VE Group. Nor may it be used in any other way or for any other purpose than expressly permitted by LU-VE Group. LU-VE Group will enforce its rights related to this document to the fullest extent of the law, including the seeking of criminal prosecution.

02	New brand	18/12/2019	PCIA	User	18/12/2019	ITALPCIA
01	Pressure transducer	08/05/2018	DRI	Proved	D. Rizzotti	
Status	change	date	name			



SIGNAL BOX LAYOUT

Document number: 9460171243-02

Sheet 6
Sh. 12

CB1

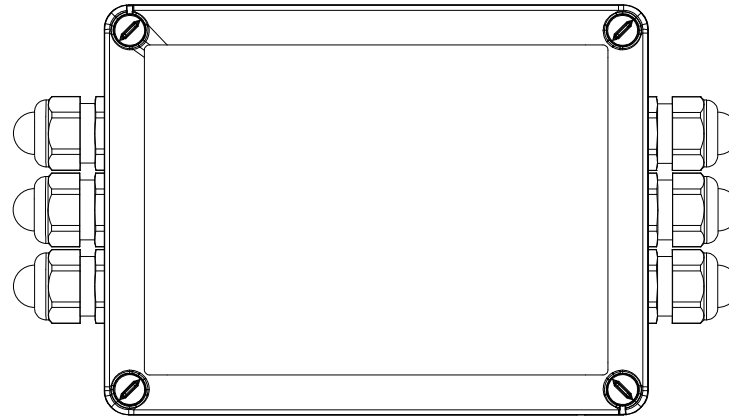
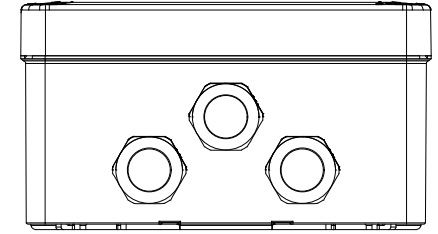
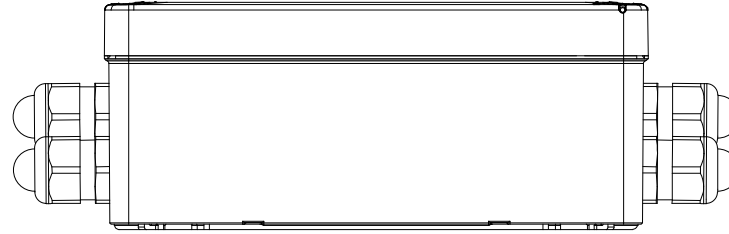
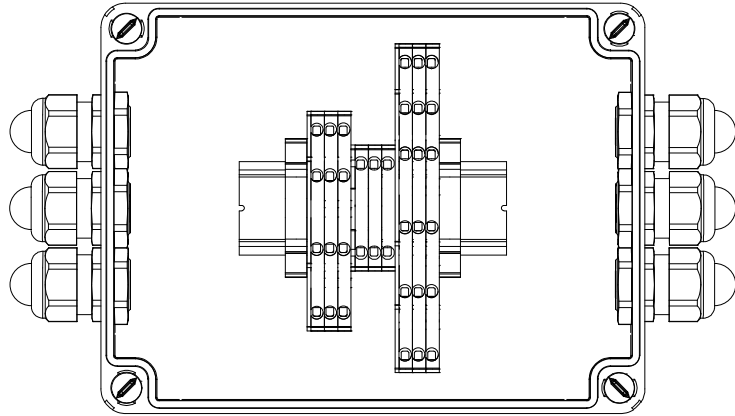

Technical data

Material: Polycarbonate
 IP protection class: IP56
 Color: RAL7035
 Rated insulation voltage: 750V
 Ambient temperature: -25/+60°C
 Dimensions: 190x140x70 mm

This document and its contents is owned by LU-VE Group or its affiliates and protected by laws governing intellectual property and thereto related rights. Without limiting any rights related to this document, no part of this document may be copied, reproduced or transmitted in any form or by any means (electronic, mechanical, photocopying, recording, or otherwise), or for any purpose, without the expressed permission of LU-VE Group. Nor may it be used in any other way or for any other purpose than expressly permitted by LU-VE Group. LU-VE Group will enforce its rights related to this document to the fullest extent of the law, including the seeking of criminal prosecution.

02	New brand	18/12/2019	PCIA	User	ITALPCIA
01	Pressure transducer	08/05/2018	DRI	Proved	D. Rizzotti
Status	change	date	name		



CONNECTION BOX LAYOUT
 3 FANS - 3 PHASE

Document number: 9460171243-02

Sheet 7
 Sh. 12

CB1

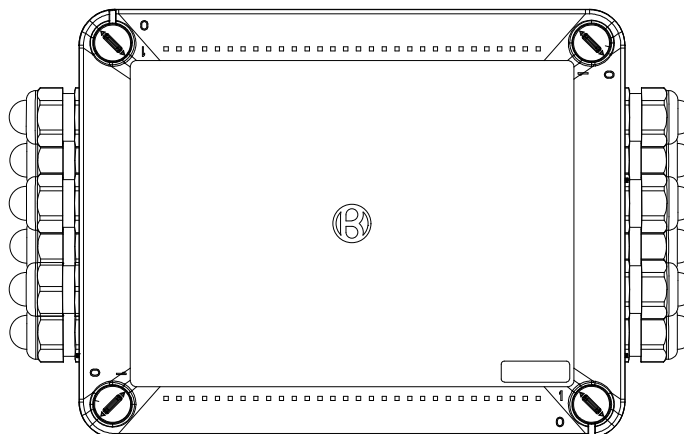
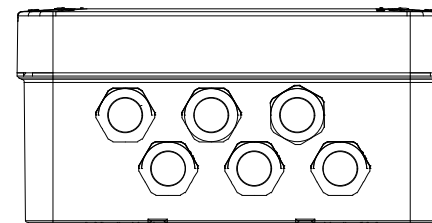
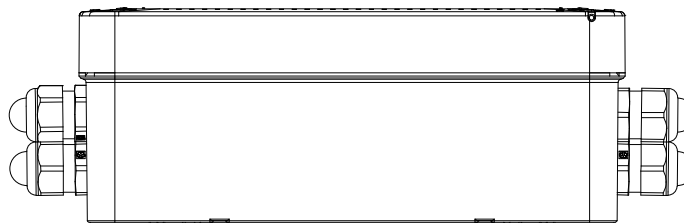
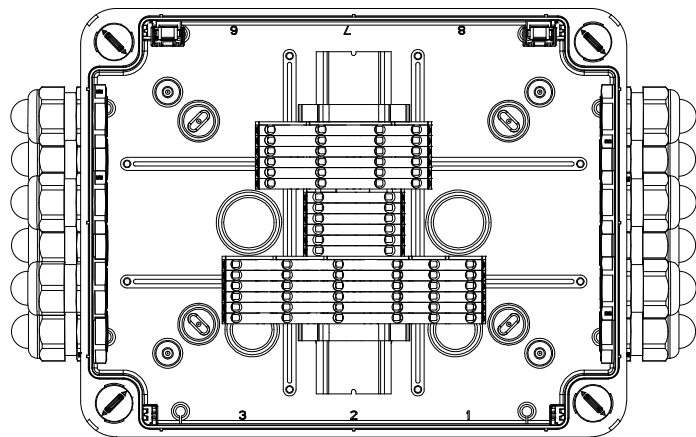

This document and its contents is owned by LU-VE Group or its affiliates and protected by laws governing intellectual property and thereto related rights. Without limiting any rights related to this document, no part of this document may be copied, reproduced or transmitted in any form or by any means (electronic, mechanical, photocopying, recording, or otherwise), or for any purpose, without the expressed permission of LU-VE Group. Nor may it be used in any other way or for any other purpose than expressly permitted by LU-VE Group. LU-VE Group will enforce its rights related to this document to the fullest extent of the law, including the seeking of criminal prosecution.

Technical data

Material: Polycarbonate
IP protection class: IP56
Color: RAL7035
Rated insulation voltage: 750V
Ambient temperature: -25/+60°C
Dimensions: 240x190x90 mm

02	New brand	18/12/2019	PCIA	User	ITALPCIA
01	Pressure transducer	08/05/2018	DRI	Proved	D. Rizzotti
Status	change	date	name		



CONNECTION BOX LAYOUT
7 FANS - 3 PHASE

Document number: 9460171243-02

Sheet 8
 Sh. 12

EC MOTORS POWER CONNECTION

3-phase motors - single row

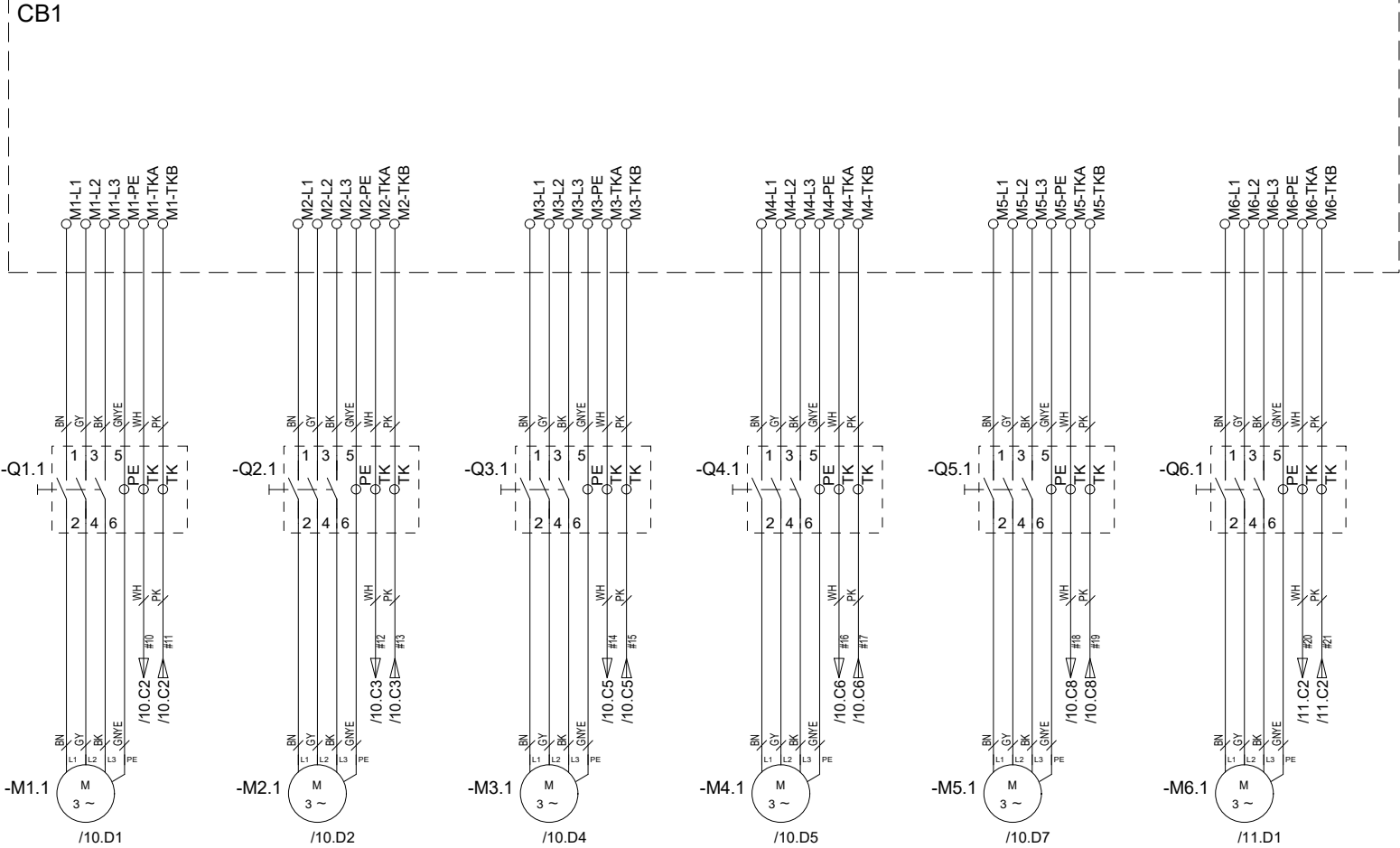

This document and its contents is owned by LU-VE Group or its affiliates and protected by laws governing intellectual property and thereto related rights. Without limiting any rights related to this document, no part of this document may be copied, reproduced or transmitted in any form or by any means (electronic, mechanical, photocopying, recording, or otherwise), or for any purpose, without the expressed permission of LU-VE Group. Nor may it be used in any other way or for any other purpose than expressly permitted by LU-VE Group. LU-VE Group will enforce its rights related to this document to the fullest extent of the law, including the seeking of criminal prosecution.

NOTE: switch for maintenance before motors are optional fans number according to unit datasheet

02	New brand	18/12/2019	PCIA	User	ITALPCIA
01	Pressure transducer	08/05/2018	DRI	Proved	D. Rizzotti
Status	change	date	name		



EC MOTORS POWER CONNECTION
3-phase motors

Document number: 9460171243-02

Sheet 9
Sh. 12

This document and its contents is owned by LU-VE Group or its affiliates and protected by laws governing intellectual property and thereto related rights. Without limiting any rights related to this document, no part of this document may be copied, reproduced or transmitted in any form or by any means (electronic, mechanical, photocopying, recording, or otherwise), or for any purpose, without the expressed permission of LU-VE Group. Nor may it be used in any other way or for any other purpose than expressly permitted by LU-VE Group. LU-VE Group will enforce its rights related to this document to the fullest extent of the law, including the seeking of criminal prosecution.

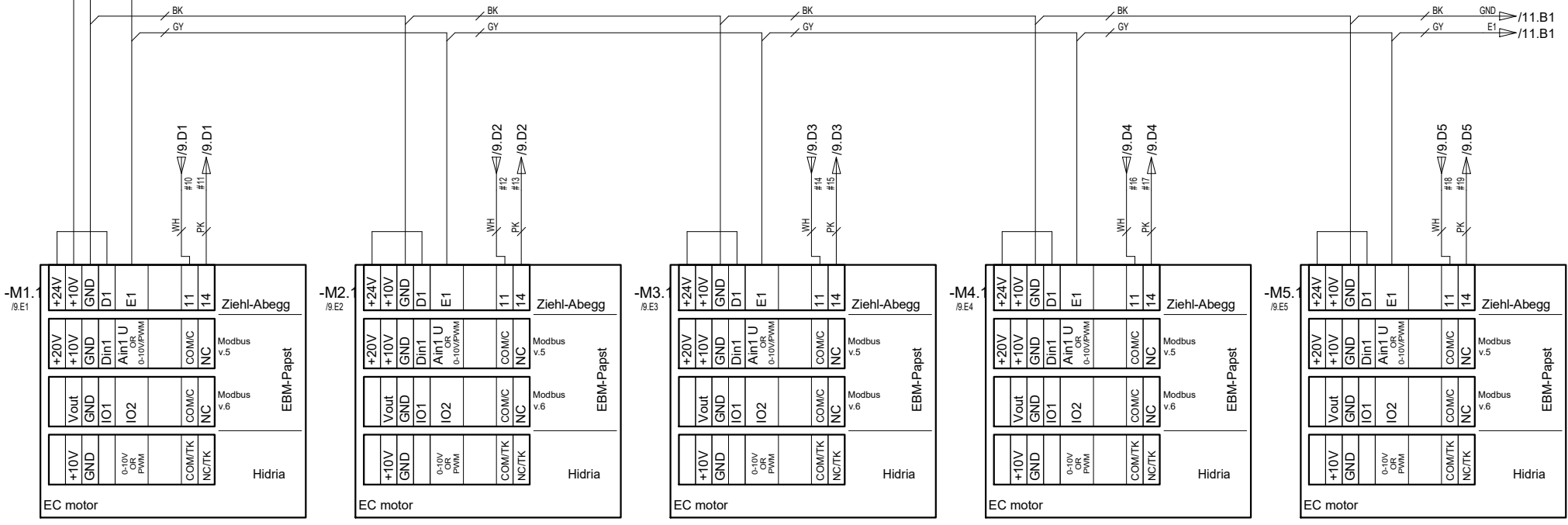
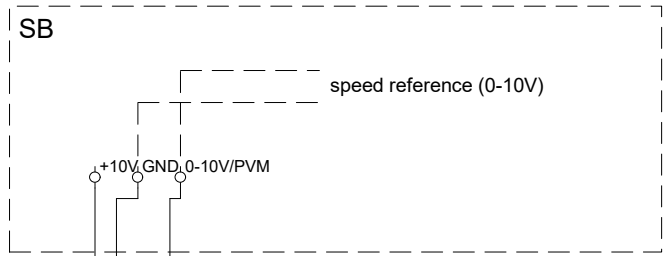

NOTE: fans number according to unit datasheet
* Connection needed only for Ziehl-Abegg fans

02	New brand	18/12/2019	PCIA	User	18/12/2019	ITALPCIA
01	Pressure transducer	08/05/2018	DRI	Proved		D. Rizzotti
Status	change	date	name			



EC MOTORS SIGNAL CONNECTION
3-phase motors

Document number: 9460171243-02

This document and its contents is owned by LU-VE Group or its affiliates and protected by laws governing intellectual property and thereto related rights. Without limiting any rights related to this document, no part of this document may be copied, reproduced or transmitted in any form or by any means (electronic, mechanical, photocopying, recording, or otherwise), or for any purpose, without the expressed permission of LU-VE Group. Nor may it be used in any other way or for any other purpose than expressly permitted by LU-VE Group. LU-VE Group will enforce its rights related to this document to the fullest extent of the law, including the seeking of criminal prosecution.

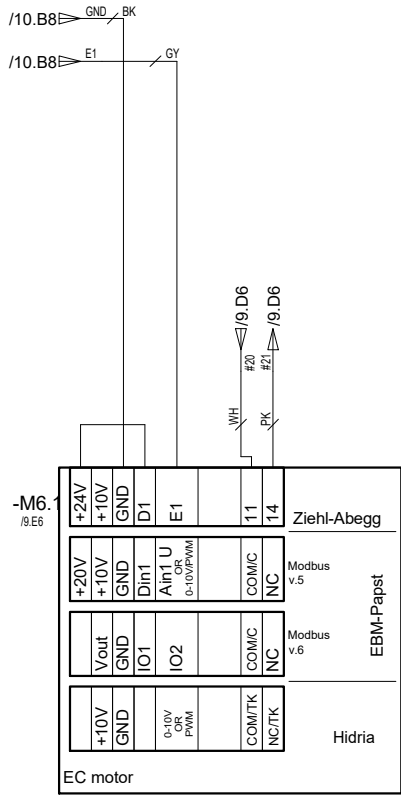

NOTE: fans number according to unit datasheet
*** Connection needed only for Ziehl-Abegg fans**

02	New brand	18/12/2019	PCIA	User	ITALPCIA
01	Pressure transducer	08/05/2018	DRI	Proved	D. Rizzotti
Status	change	date	name		



EC MOTORS SIGNAL CONNECTION
3-phase motors

Document number: **9460171243-02**

OPTIONAL PRESSURE TRANSDUCER

Type	CBG-30AV	CBG-50AV
Code	41003168	41003169
Scale Range	0-30 bar	0-50 bar
Setpoint Adjustment	6-21 bar	10-35 bar
Control range Adjustment	3-9 bar	5-15 bar

PRESSURE TRANSDUCER 0-10V
0-30/50 bar

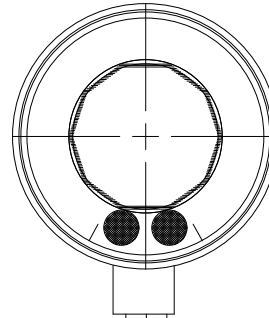

signal box

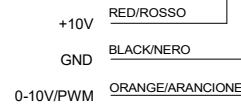

This document and its contents is owned by LU-VE Group or its affiliates and protected by laws governing intellectual property and thereto related rights. Without limiting any rights related to this document, no part of this document may be copied, reproduced or transmitted in any form or by any means (electronic, mechanical, photocopying, recording, or otherwise), or for any purpose, without the expressed permission of LU-VE Group. Nor may it be used in any other way or for any other purpose than expressly permitted by LU-VE Group. LU-VE Group will enforce its rights related to this document to the fullest extent of the law, including the seeking of criminal prosecution.

02	New brand	18/12/2019	PCIA	User	18/12/2019	ITALPCIA
01	Pressure transducer	08/05/2018	DRI	Proved	D. Rizzotti	
Status	change	date	name			



PRESSURE TRANSDUCER
OPTIONAL

Document number: 9460171243-02

Sheet 12
Sh. 12