

# Electric

This document and its contents is owned by Luvé Group or its affiliates and protected by laws governing intellectual property and therefore related rights. Without limiting any rights related to this document, no part of this document may be copied, reproduced or transmitted in any form or by any means (electronic, mechanical, photocopying, recording, or otherwise), or for any purpose, without the expressed permission of Luvé Group. Nor may it be used in any other way or for any other purpose than expressly permitted by Luvé Group. Luvé Group will enforce its rights related to this document to the fullest extent of the law, including the seeking of criminal prosecution.

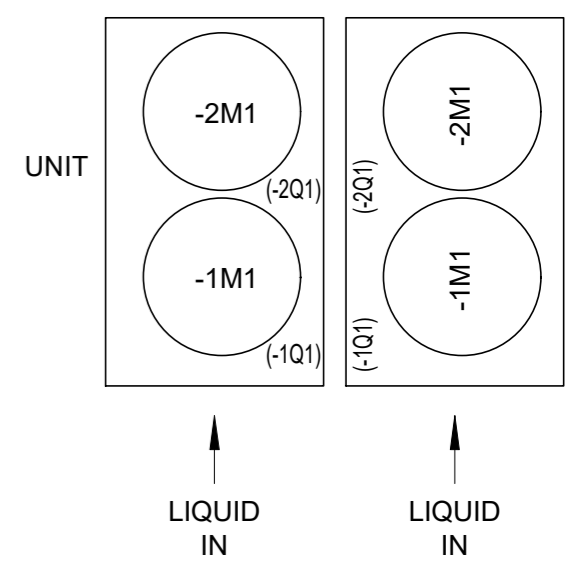
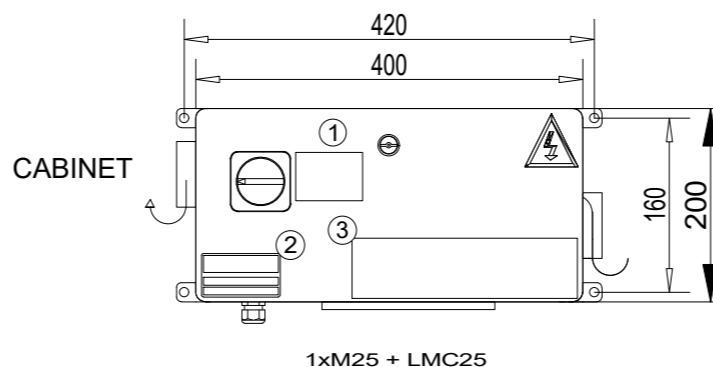
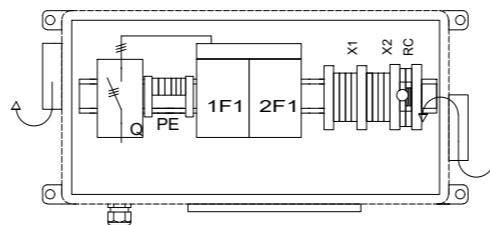

FAN Item number		FAN pcs	POWER kW	CURRENT A (+20°C)	RPM
9460140573/S	SM, SRM, -09TD	2	2,88	4,4	1000
9460140573/S	SM, SRM, -09SD	2	1,44 (Nom.2,88)	2,32 (Nom. 4,4)	781 (Nom. 1000)
9460140573/S	SM, SRM, -09LD	2	0,73 (Nom.2,88)	1,32 (Nom. 4,4)	612 (Nom. 1000)
9460140573/S	SM, SRM, -09QD	2	0,45 (Nom.2,88)	0,92 (Nom. 4,4)	511 (Nom. 1000)
9460140573/S	SM, SRM, -09RD	2	0,22 (Nom.2,88)	0,56 (Nom. 4,4)	385 (Nom. 1000)
9460170812/S	SM, SRM, -09LD	2	0,73	1,32	612
9460170812/S	SM, SRM, -09QD	2	0,45 (Nom. 0,73)	0,92 (Nom. 1,32)	511 (Nom. 612)
9460170812/S	SM, SRM, -09RD	2	0,22 (Nom. 0,73)	0,56 (Nom. 1,32)	385 (Nom. 612)
9460140573/S	SM, SRM, -09TY	2	2,1 (Nom.2,88)	3,23 (Nom. 4,4)	890 (Nom. 1000)
9460140573/S	SM, SRM, -09SY	2	1,04 (Nom.2,88)	1,76 (Nom. 4,4)	695 (Nom. 1000)
9460140573/S	SM, SRM, -09LY	2	0,57 (Nom.2,88)	1,10 (Nom. 4,4)	560 (Nom. 1000)
9460140573/S	SM, SRM, -09QY	2	0,30 (Nom.2,88)	0,70 (Nom. 4,4)	440 (Nom. 1000)
9460140573/S	SM, SRM, -09RY	2	0,16 (Nom.2,88)	0,48 (Nom. 4,4)	345 (Nom. 1000)
9460170812/S	SM, SRM, -09LY	2	0,57 (Nom. 0,73)	1,10 (Nom. 1,32)	560 (Nom. 612)
9460170812/S	SM, SRM, -09QY	2	0,30 (Nom. 0,73)	0,70 (Nom. 1,32)	440 (Nom. 612)
9460170812/S	SM, SRM, -09RY	2	0,16 (Nom. 0,73)	0,48 (Nom. 1,32)	345 (Nom. 612)

①  
**MAIN SWITCH**  
**PÄÄKYTKIN**  
**HUVUDBRYTARE**  
**HAUPTSCHALTER**  
**ГЛАВНЫЙ ВЫКЛЮЧАТЕЛЬ**  
**INTERRUPTORE PRINCIPALE**  
**INTERUPTEUR PRINCIPAL**  
**INTERRUPTOR PRINCIPAL**

②

Model			ECCB 1x2		
In/A	16	Un/V	400	ac	
Icc/kA		IP	65		
Type.no.	EN 61439				

③

**WARNING!**  
**VAROITUS!**  
**VARNING!**  
**WARNUNG!**  
**ВНИМАНИЕ!**  
**ATTENZIONE!**  
**AVERTISSEMENT!**  
**ADVERTENCIA!**

Wait five minutes after disconnecting the voltage at all poles before opening the device.  
 Odota viisi minuuttia sen jälkeen, kun jännite on katkaistu kaikilta navoilta.  
 Rör inte vid apparaten förrän fem minuter efter avstängning av spänningen på alla poler.  
 Gerät erst fünf Minuten nach allpoligem Abschalten der Spannung öffnen.  
 Открывайте устройство только через 5 минут после отключения напряжения по всем полюсам.  
 Aprire l'apparecchio solo dopo cinque minuti dal disinserimento onnipolare della tensione.  
 N'ouvrez l'appareil que cinq minutes après coupure de la tension sur tous les pôles.  
 Abrir el equipo cinco minutos después de la desconexión completa de la tensión.

date	24.1.2020
User	FIVAJMN
Proved	FIVAJMN
Status change	date name



ECCBI, 4...20mA

Document number: 9460177928-00

Sheet 1  
Sh. 5

# Electric

This document and its contents is owned by Luve Group or its affiliates and protected by laws governing intellectual property and related rights. Without limiting any rights related to this document, no part of this document may be copied, reproduced or transmitted in any form or by any means (electronic, mechanical, photocopying, recording, or otherwise), or for any purpose, without the expressed permission of Luve Group. Nor may it be used in any other way or for any other purpose than expressly permitted by Luve Group. Luve Group will enforce its rights related to this document to the fullest extent of the law, including the seeking of criminal prosecution.

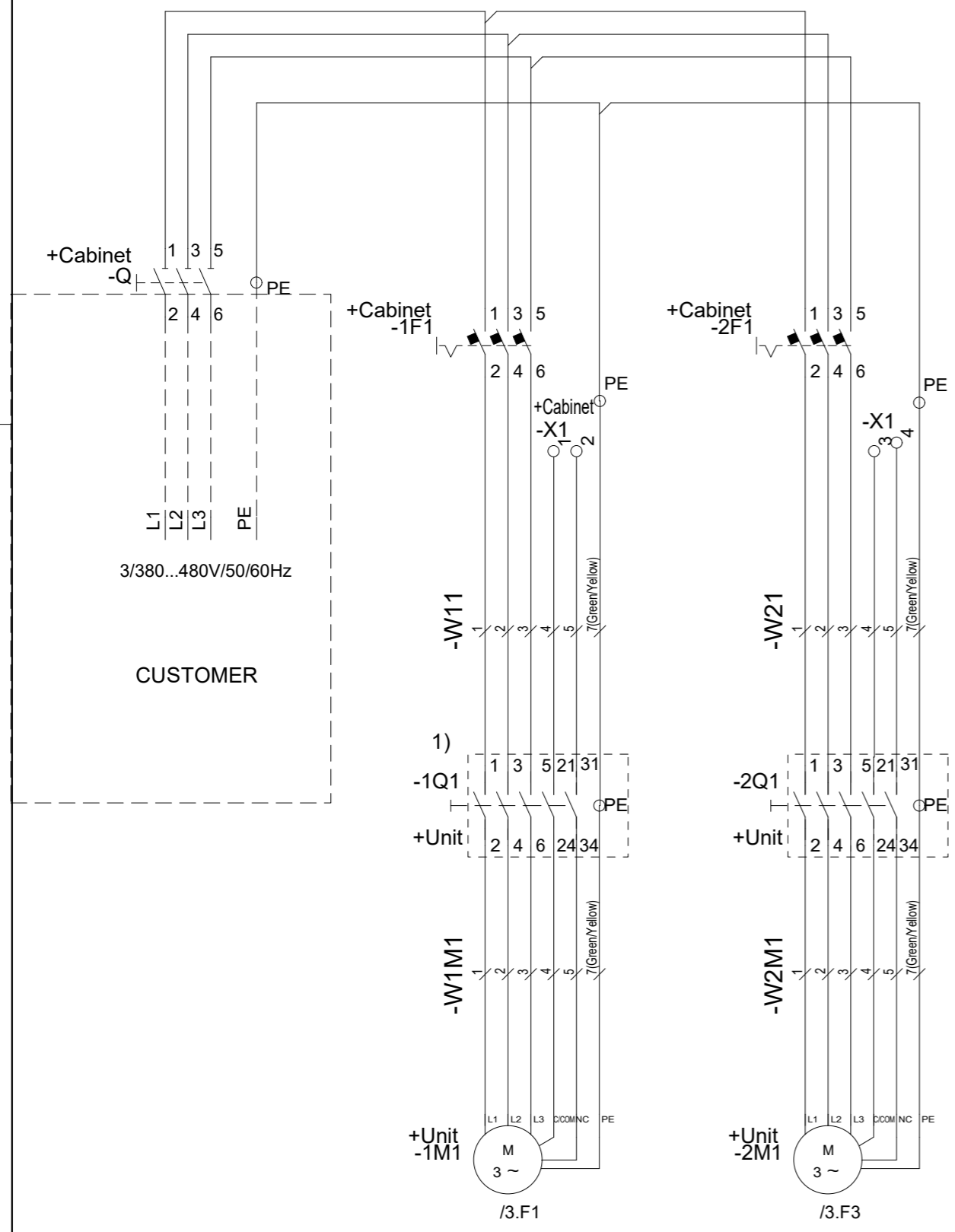

date	24.1.2020
User	FIVAJMN
Proved	FIVAJMN
Status change	date name



ECCBI, 4...20mA

Document number: 9460177928-00

Sheet 2  
Sh. 5

This document and its contents is owned by Luve Group or its affiliates and protected by laws governing intellectual property and related rights. Without limiting any rights related to this document, no part of this document may be copied, reproduced or transmitted in any form or by any means (electronic, mechanical, photocopying, recording, or otherwise), or for any purpose, without the expressed permission of Luve Group. Nor may it be used in any other way or for any other purpose than expressly permitted by Luve Group. Luve Group will enforce its rights related to this document to the fullest extent of the law, including the seeking of criminal prosecution.

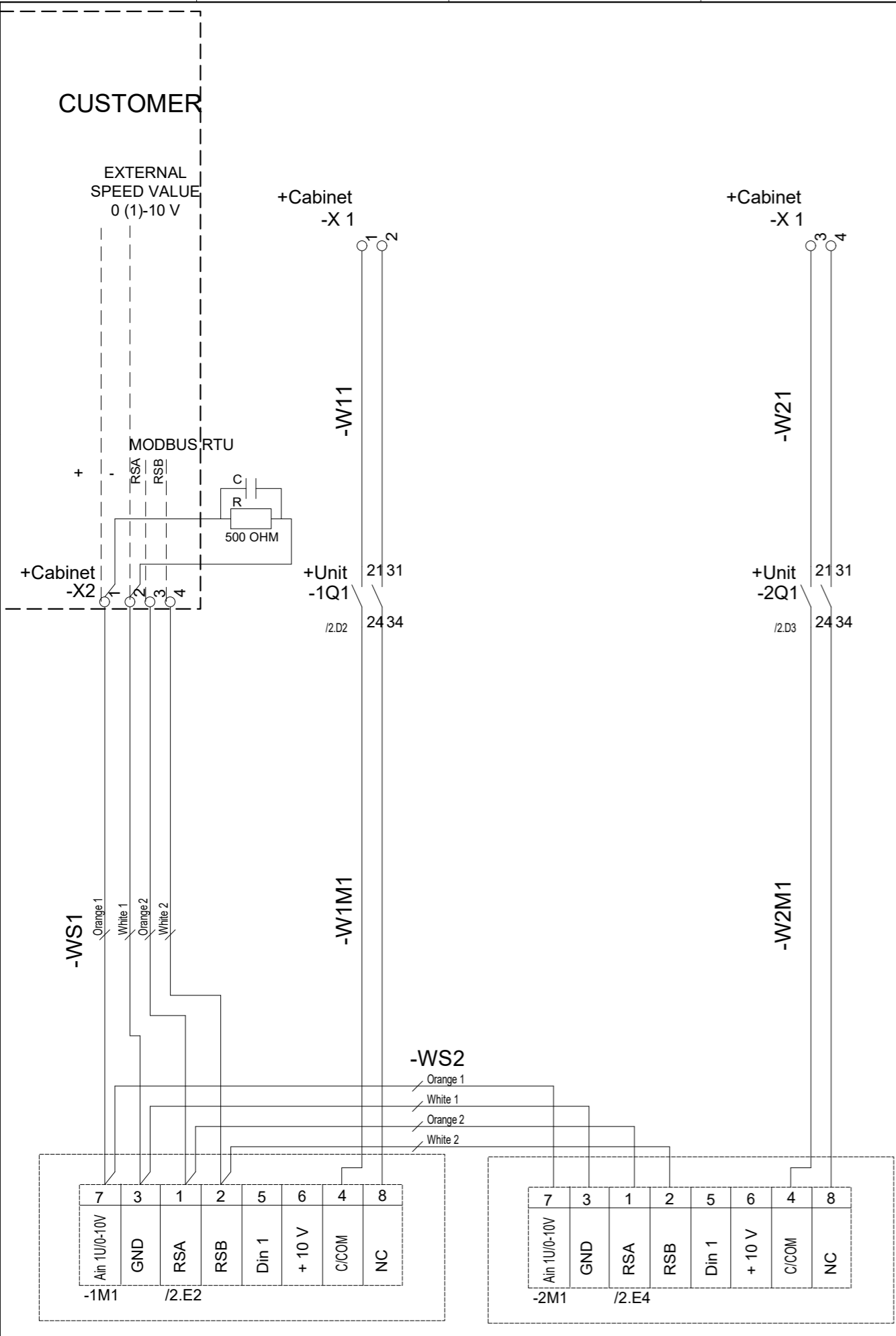

date	24.1.2020
User	FIVAJMN
Proved	FIVAJMN
Status change	date name



ECCBI, 4...20mA

terminal strip

-X1

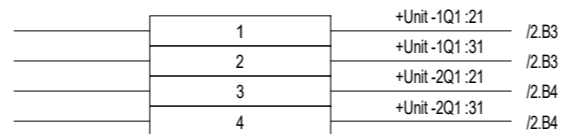

This document and its contents is owned by Luve Group or its affiliates and protected by laws governing intellectual property and therefore related to this document. Without limiting rights related to this document, this document is not to be reproduced, stored in a retrieval system, or transmitted in any form or by any means (electronic, mechanical, photocopying, recording, or otherwise) for any purpose without the expressed permission of Luve Group. Nor may it be used in any other way or for any other purpose than expressly permitted by Luve Group. Luve Group will enforce its rights related to this document to the fullest extent of the law, including the seeking of criminal prosecution.

date	24.1.2020
User	FIVAJMN
Proved	FIVAJMN
Status	change
date	
name	



ECCBI, 4...20mA

+Cabinet

Document number: 9460177928-00

Sheet 4  
Sh. 5

terminal strip

-X2

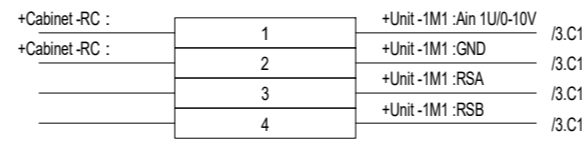

This document and its contents is owned by Luve Group or its affiliates and protected by laws governing intellectual property and therefore related to this. Without limiting rights related to this document, this document is not to be copied, reproduced, distributed, or otherwise used in any form or by any means (electronic, mechanical, photocopying, recording, or otherwise) for any purpose without the expressed permission of Luve Group. Nor may it be used in any other way or for any other purpose than expressly permitted by Luve Group. Luve Group will enforce its rights related to this document to the fullest extent of the law, including the seeking of criminal prosecution.

date	24.1.2020
User	FIVAJMN
Proved	FIVAJMN
Status	change
date	
name	



ECCBI, 4...20mA

Document number: 9460177928-00

Sheet 5  
Sh. 5

+Cabinet